

# SAK AUTOMATIC PACKAGE CHANGER

LH-132, LH-133 SAK



## AUTOMATE YOUR TESTING

In today's modern textile mills, where quality and cost cutting are most important, there is a great need for high volume testing. Many of today's testing instruments do not have an automatic yarn changer, requiring an operator, which is very costly. Lawson Hemphill offers you a solution with the new Air SAK (Sample Automatic Changer).

The new SAK allows the operator to service and operate more than one machine simultaneously, saving operator costs and reducing down time of testing instruments. For example, with the 48-position rotary magazine one can preload up to 36 ends at one time. If the test duration per sample is one minute, the SAK will run continuously for 36 minutes before the operator will have to supply more yarn. The SAK provides start and stop signals to a host instrument.

The mechanics of the system include a modern programmable controller used in conjunction with pneumatic cylinders to execute the knotter and rotary magazine with rapier. This provides dependable operation with little maintenance.

## FEATURES

- Sequentially and automatically knot preset sample lengths of yarn into a continuous thread line to automate testing equipment such as lab knitting machines, entanglement tester, shrinkage tester and others.
- Knotted yarn samples may be produced up to 500 meters per minute.
- Run your test by loading the SAK directly from a creel. Yarn packages to be sampled can be fed with a variety of creel systems to suit customer's requirements.
- Substantial labor savings. Allows one operator to operate more than one testing equipment.
- New SAK-HD for high denier (up to 3800)

# SAK AUTOMATIC PACKAGE CHANGER

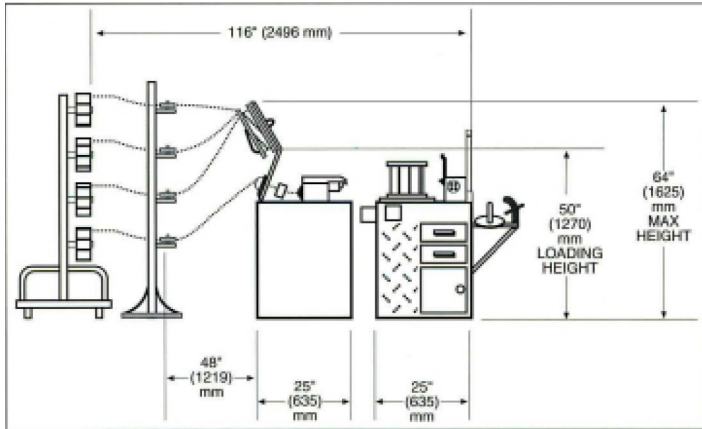

**EXAMPLE--Sample Automatic Knotter integrated to a lab knitting machine.**

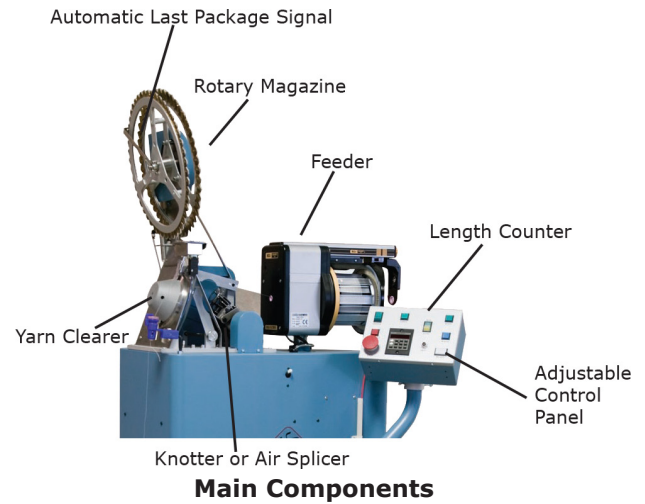

## MODELS

**LH-132 SAK** Automatic Knotter with 36 position Rotary Magazine and Rapier, for Medium Twisted & Textured Yarns 20-400 denier

**LH-133 SAK-E** Automatic Air Splicer with 36 position Rotary Magazine and Rapier, for Multi Filament low twist yarn 20-400 denier

**SAK-HD** Automatic Air Splicer for Carpet yarns and High Denier Filament yarns, for Multi Filament heavy Denier Carpet yarns 600 denier and up to 3500 denier.

Speed	Up to 500m/min
Power	Specify power when ordering 115vac @ 10 Amp or 230vac @ 5amp Single Phase power 50/60Hz
Air	100psi Clean and Dry compressed air. Consumption: 6 SCMH (200CFH)
Dimensions	40 x 80 x 1500 cm ( 16 x 31.5 x 591 in)
Weight	Net: 140Kg (280lbs) Shipping: 220Kg (450lbs)

The 36-position Rotary Magazine is a circular magazine that allows preloading 36 ends and then adds more when testing is in progress. Once the packages are loaded, the Rapier Arm automatically grabs each new yarn and loads it into position for knotting or splicing.

*\*All specifications are subject to change.*

Contact us today for more information on any Lawson-Hemphill product!

**Lawson Hemphill Inc.**  
1658 G.A.R. Highway, Unit 6  
Swansea, MA 02777 USA  
Phone: +1 508 679 5364  
information@lawsonhemphill.com  
www.lawsonhemphill.com

